

## TECHNICAL CARD

**PRODUCT NAME** : Bolt 220 black

**PRODUCT CODE** : 30.001

**TECHNICAL DATA** : Material – Steel S235JR  
Weight of 1 pc – 0,40 kg  
Coating – anticorrosive  
applied by cataphoresis  
method  
Colour – black

**APPLICATION** : Bolt for fitting fencing and  
garage hinged doors/gates.  
Closure allows door leaf to be  
locked in both positions – open  
and close.

**PRODUCER** : Komet company – Polish  
produce of construction  
hardware for gates.

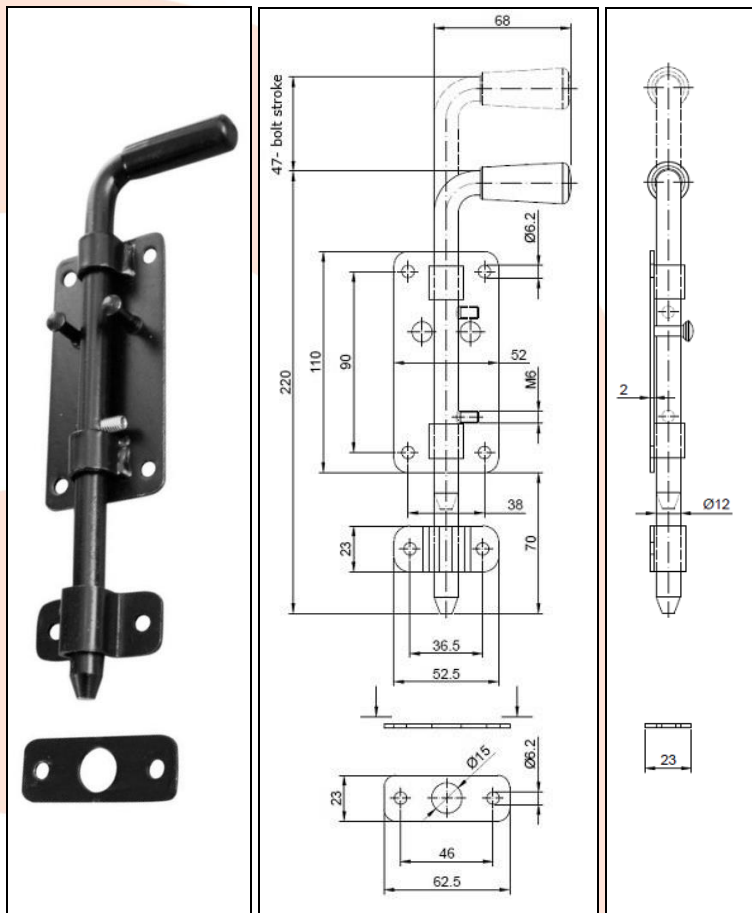

**NOTES** : All technical data are approximate values. The manufacturer reserves the right to correct the product and change the technical conditions with the possibility of making changes inside the specification. This information cannot be considered as a guarantee, nor is it legally binding in any way.