

## TECHNICAL CARD

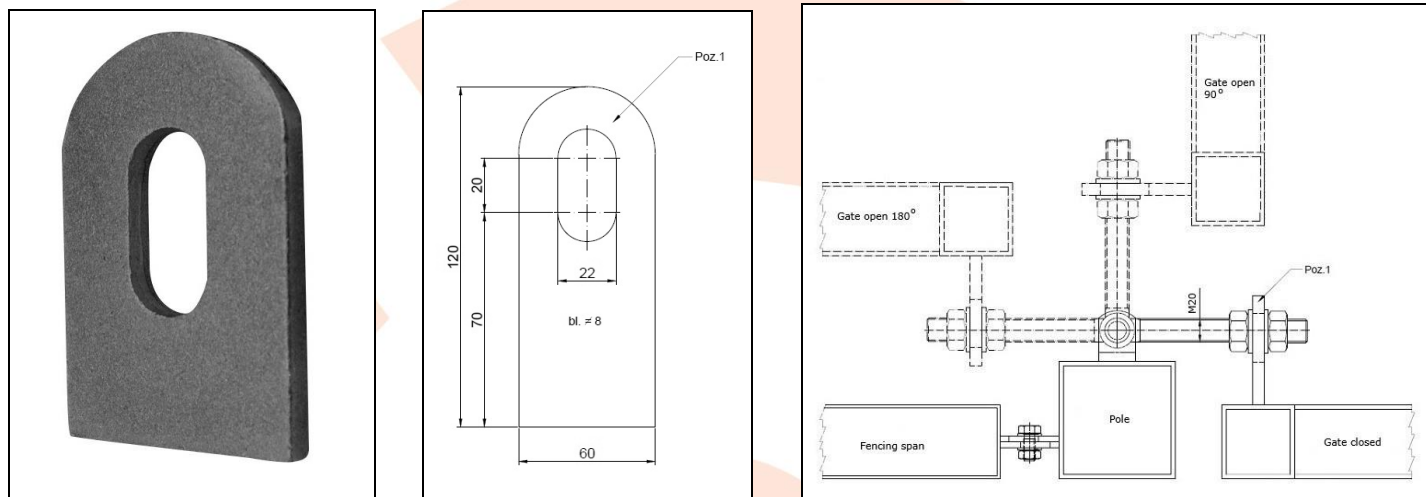

**PRODUCT NAME** : Element - opening angle 180° L-90 to M20

**ITEM CODE** : 20.016

**TECHNICAL DATA** : Material – Steel S235JR  
Weight – 0,38 kg  
Coating – scale-free, shot blasting

**APPLICATION** : The element allows to open the wicket / gate up to 180 degrees.

**PRODUCER** : Komet company – Polish produce of construction hardware for gates.

**NOTES** : All technical data are approximate values. The manufacturer reserves the right to correct the product and change the technical conditions with the possibility of making changes inside the specification. This information cannot be considered as a guarantee, nor is it legally binding in any way.