

TECHNICAL CARD

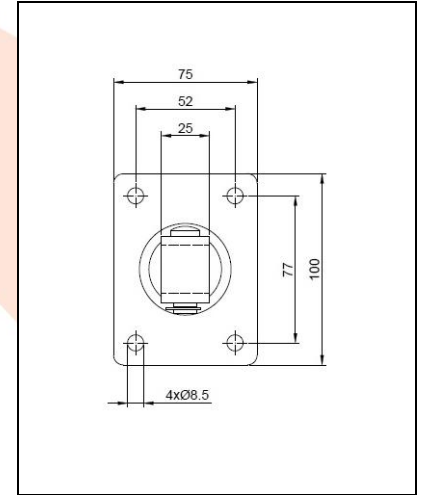
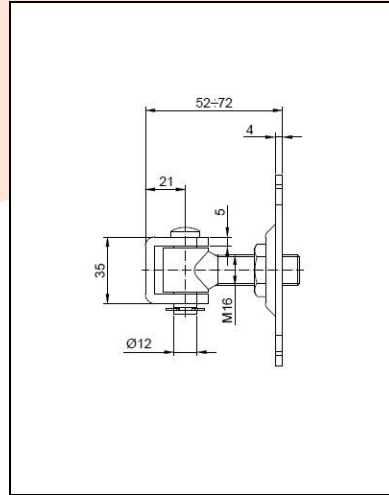

PRODUCT NAME : Adjustable hinge M16 base 100x75x4

ITEM CODE : 16.004

TECHNICAL DATA : Material – S235JR steel
Weight of 1 pc – 0.45 kg
Coating – galvanic zinc
Color – white zinc

APPLICATION : The adjustable hinge is used for fitting wickets/fences and garage gates. The hinge allows to adjust the distance between the pole and the gate leaf. Adjustments can be made without disassembling the leaf.

PRODUCER : Komet company – Polish produce of construction hardware for gates.

NOTES : All technical data are approximate values. The manufacturer reserves the right to correct the product and change the technical conditions with the possibility of making changes inside the specification. This information cannot be considered as a guarantee, nor is it legally binding in any way.