

TECHNICAL CARD

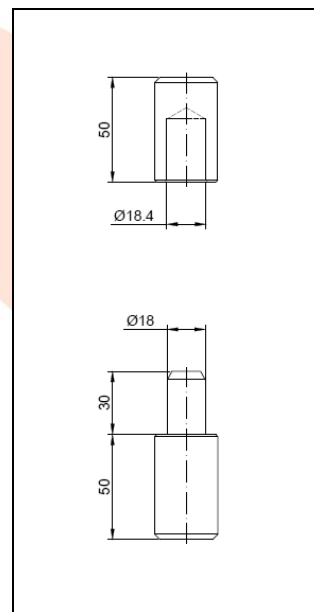
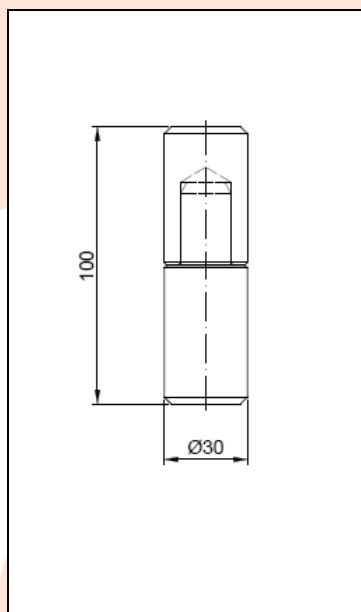

PRODUCT NAME : Turned hinge Ø 30

ITEM CODE : 10.030

TECHNICAL DATA : Material – Steel S235JR
Weight of 1 pc – 0,54 kg
Coating – scale-free, shot blasting

APPLICATION : Turned hinge is used to fitting wicket/fence and garage gates.

PRODUCENT : Komet company – Polish producer of construction hardware for gates.

NOTES: All technical data are approximate values. The manufacturer reserves the right to correct the product and change the technical conditions with the possibility of making changes inside the specification. This information cannot be considered as a guarantee, nor is it legally binding in any way.