

TECHNICAL CARD

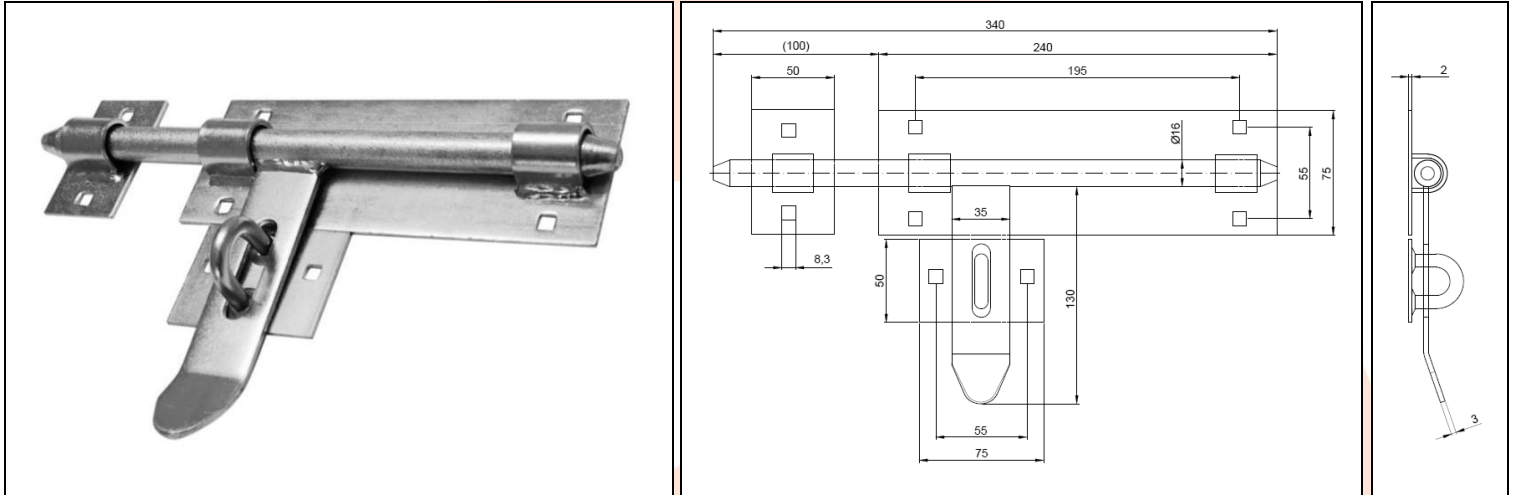

PRODUCT NAME : Slide bolt 340 galvanized

ITEM CODE : 30.106

TECHNICAL DATA : Material – S235JR steel
Weight of 1 pc – 1.12 kg
Coating – galvanic zinc
Color – white zinc

APPLICATION : The slide bolt is used for fitting fencing and garage doors and gates. The lock locks the gate leaves and enables protection with a padlock against opening.

PRODUCER : Komet company – Polish produce of construction hardware for gates.

NOTES : All technical data are approximate values. The manufacturer reserves the right to correct the product and change the technical conditions with the possibility of making changes inside the specification. This information cannot be considered as a guarantee, nor is it legally binding in any way.