

## TECHNICAL CARD

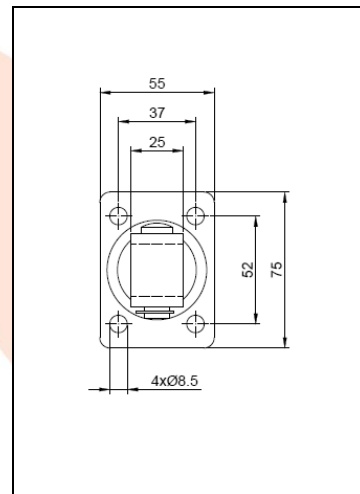
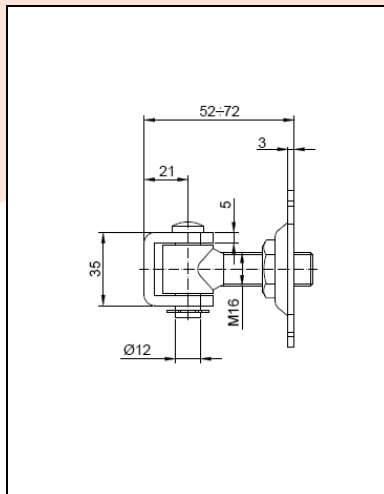

**PRODUCT NAME** : Adjustable hinge M16 base 75x55x3

**ITEM CODE** : 16.017

**TECHNICAL DATA** : Material – S235JR steel  
Weight of 1 pc – 0.34 kg  
Coating – galvanic zinc  
Color – white zinc

**APPLICATION** : The adjustable hinge is used for fitting wickets/fences and garage gates. The hinge allows to adjust the distance between the pole and the gate leaf. Adjustments can be made without disassembling the leaf.

**PRODUCER** : Komet company – Polish produce of construction hardware for gates.

**NOTES** : All technical data are approximate values. The manufacturer reserves the right to correct the product and change the technical conditions with the possibility of making changes inside the specification. This information cannot be considered as a guarantee, nor is it legally binding in any way.